



NOTICE DE MONTAGE KIT 3 POINTS ET 1 POINT

RENAULT KANGOO III (L2) H1 2021
(2021 à ce jour)

MERCEDES CITAN II (2022 à ce jour)

ASSA ABLOY

Une marque du Groupe ASSA

Réf : AOSR1KANLXH12021X

Réf : AOSR3KANLXH12021X

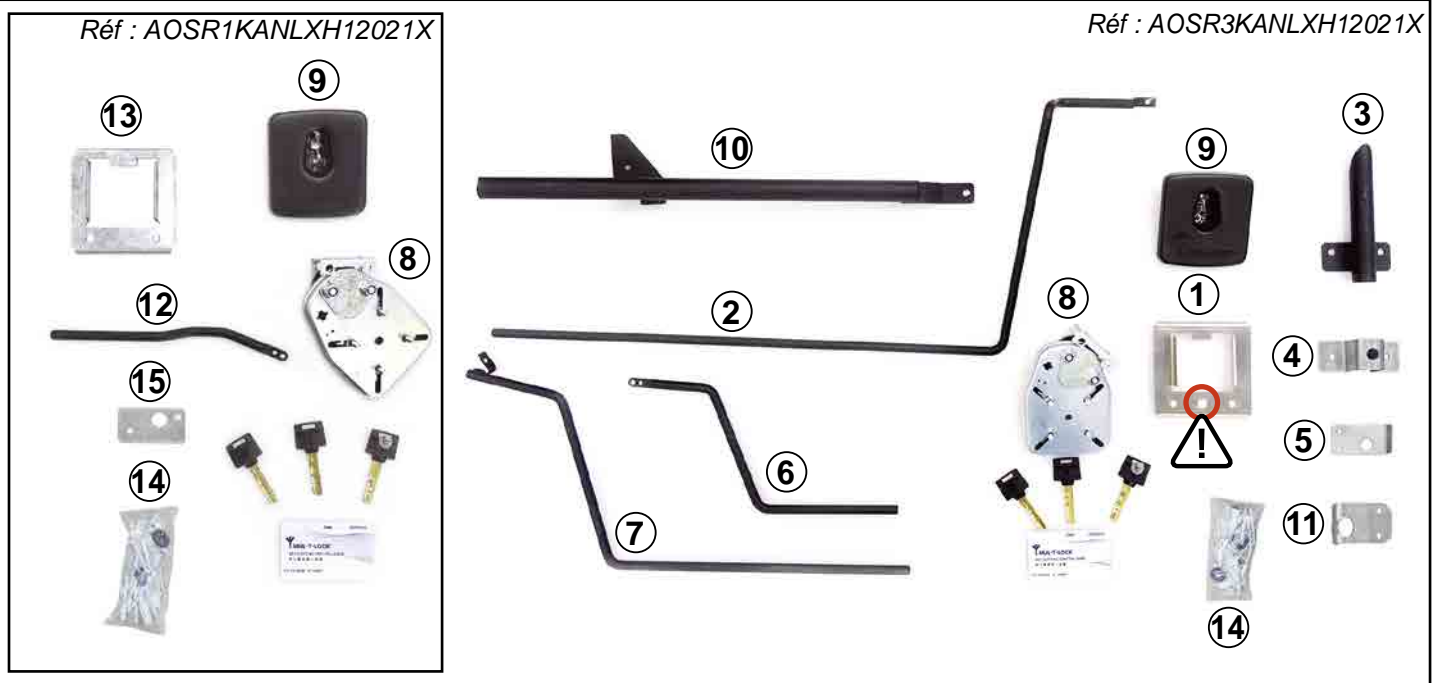

Réf : AOSR4KANL2H12021X

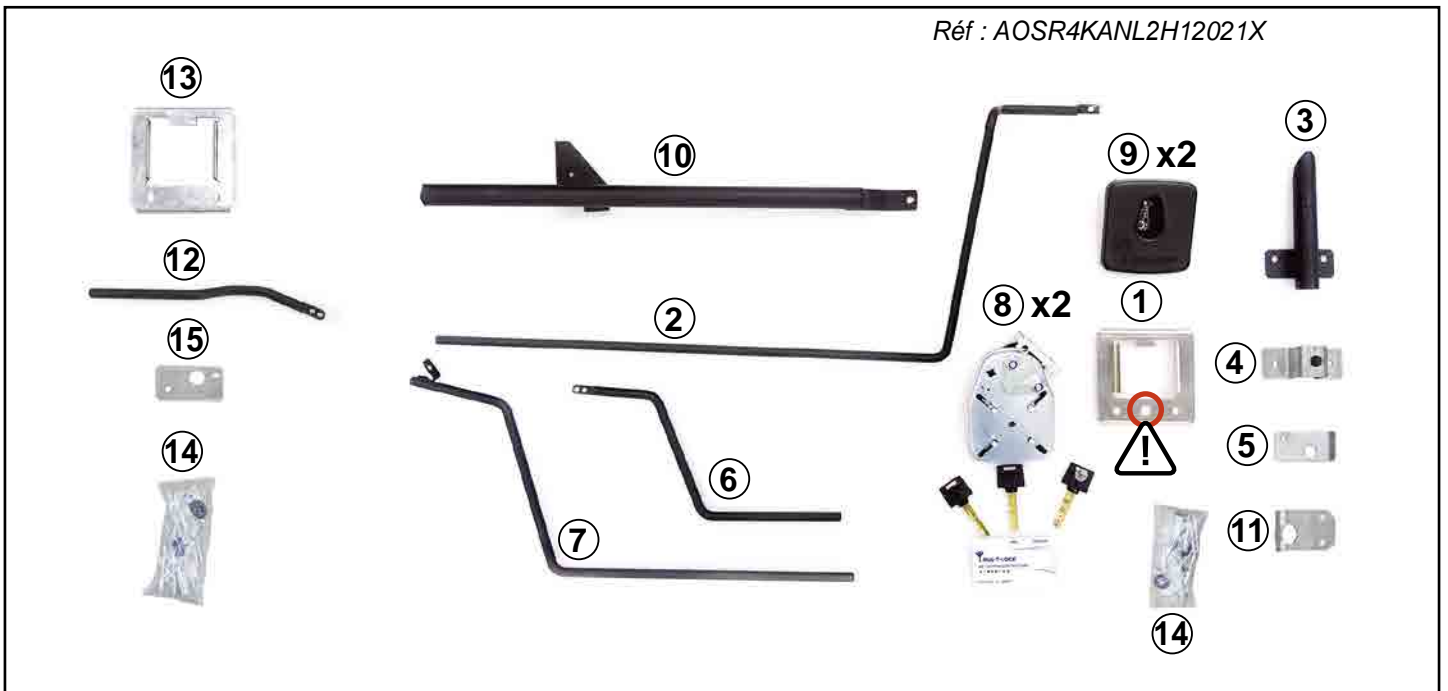

Réf : AOSR5KANLXH12021X

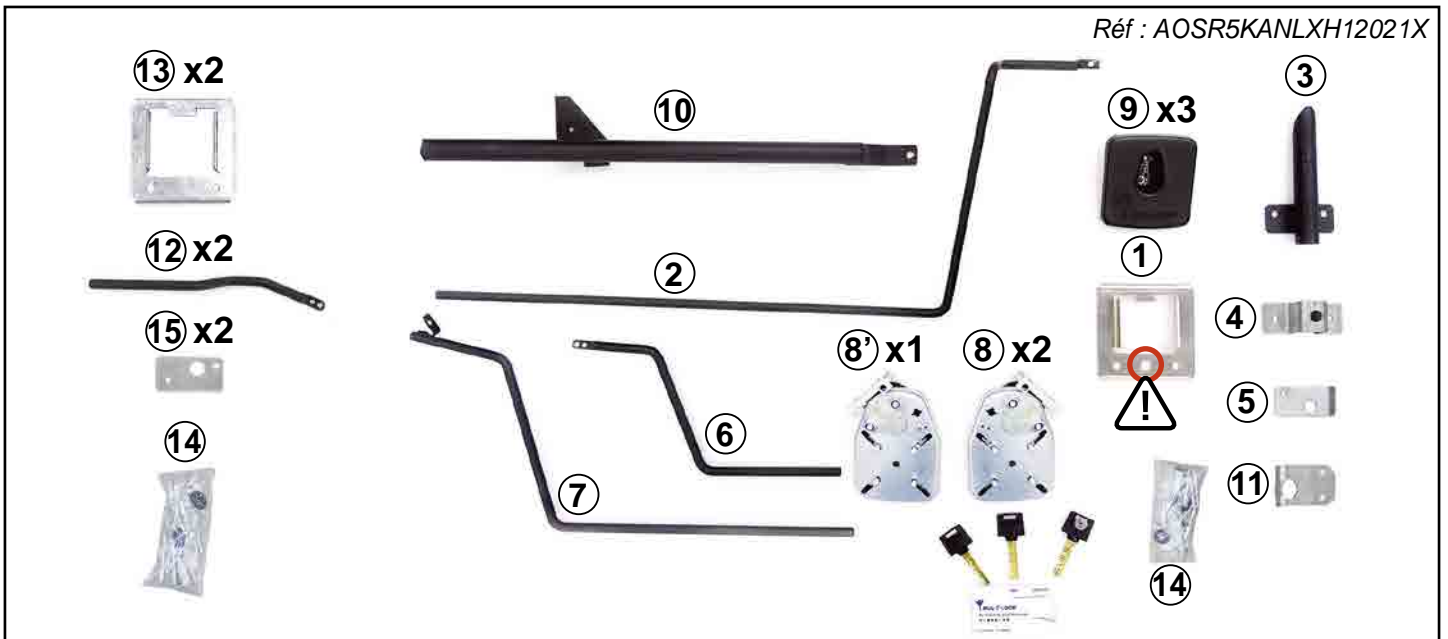

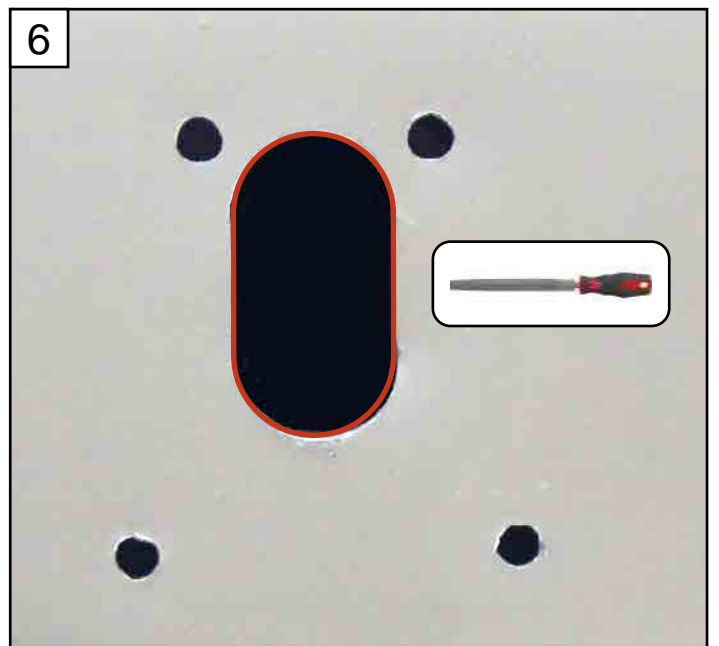
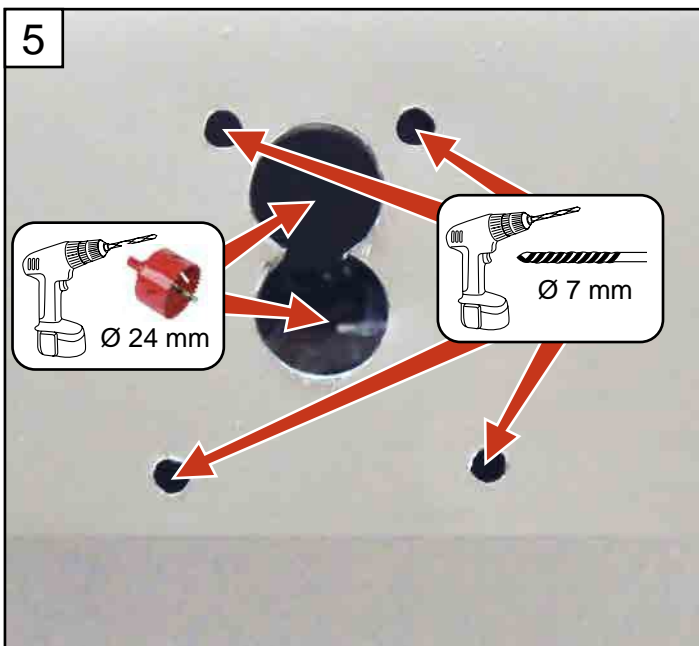
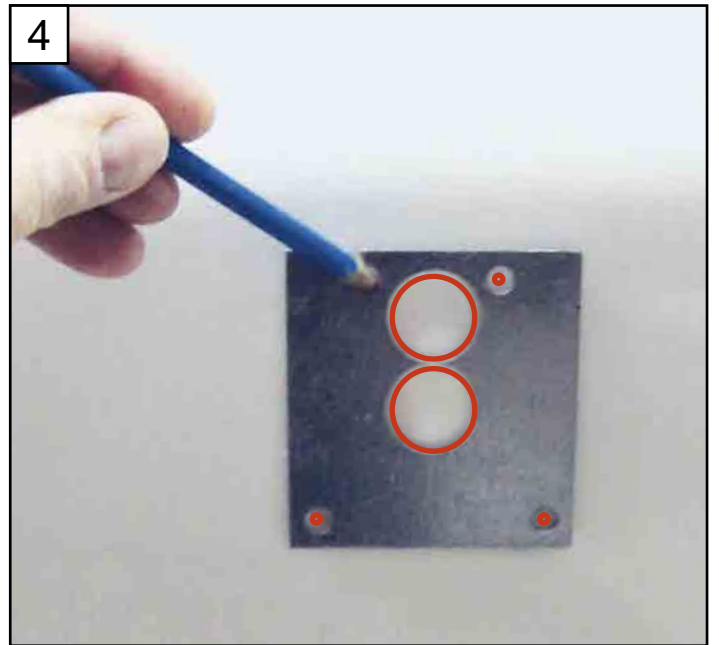
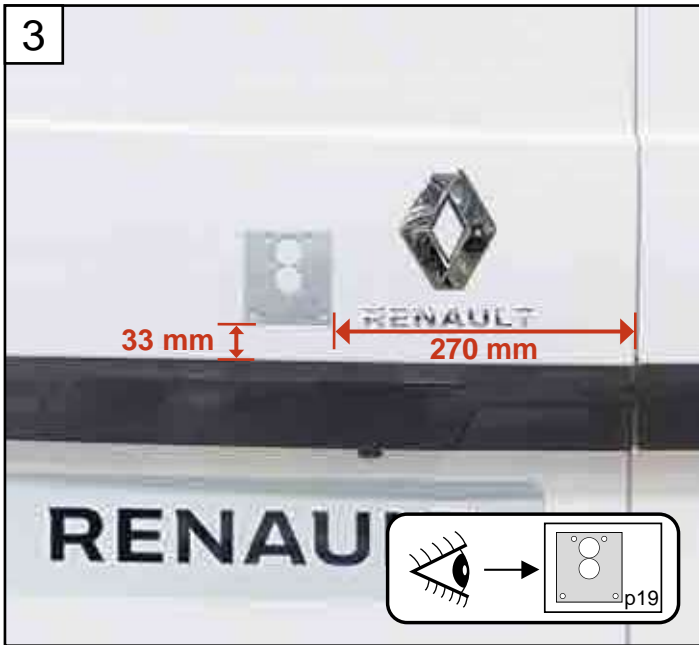
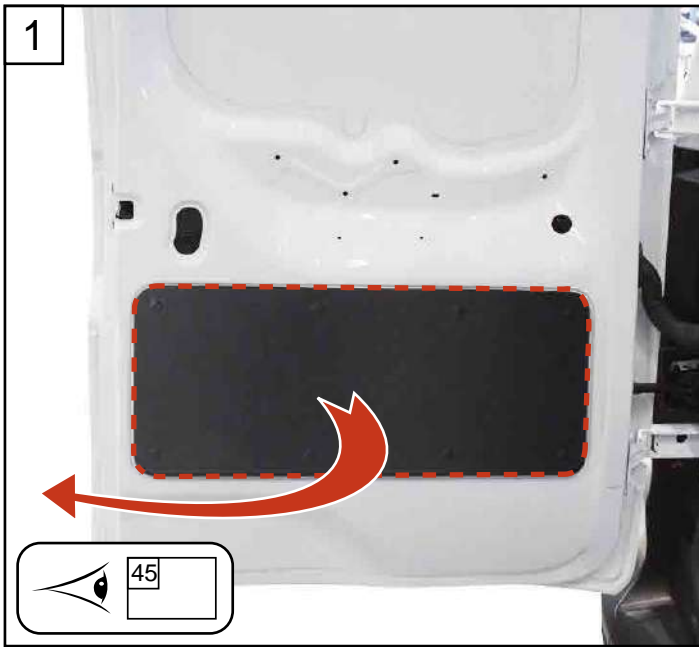

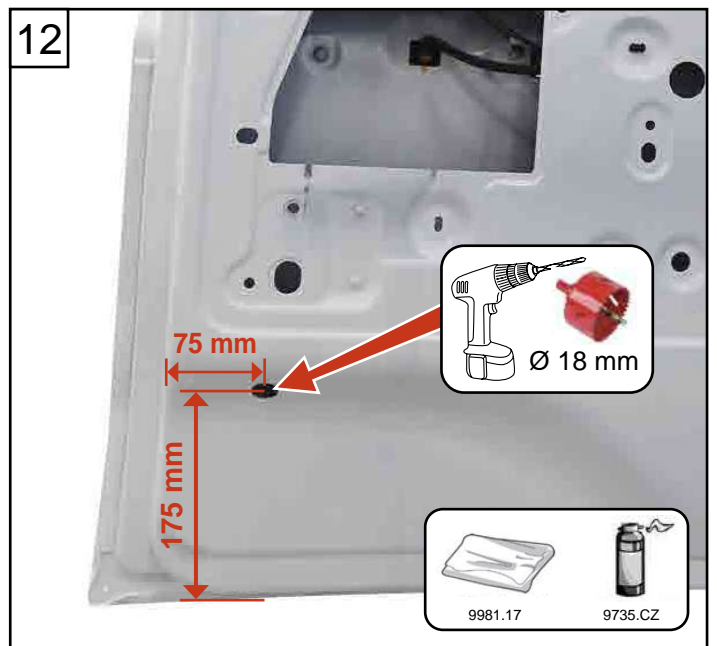
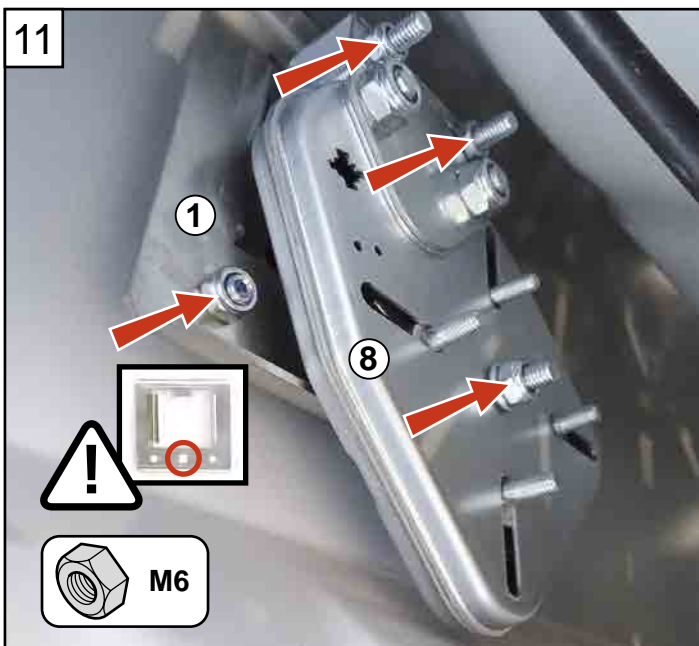
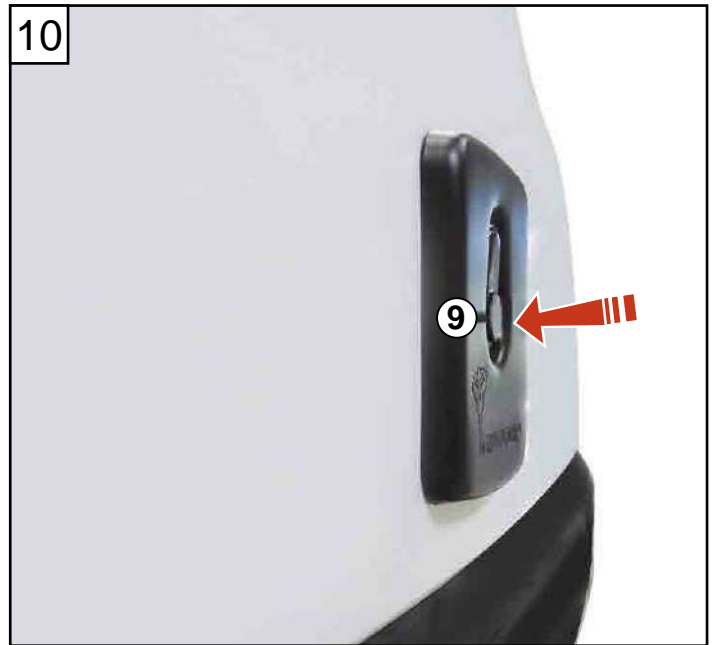
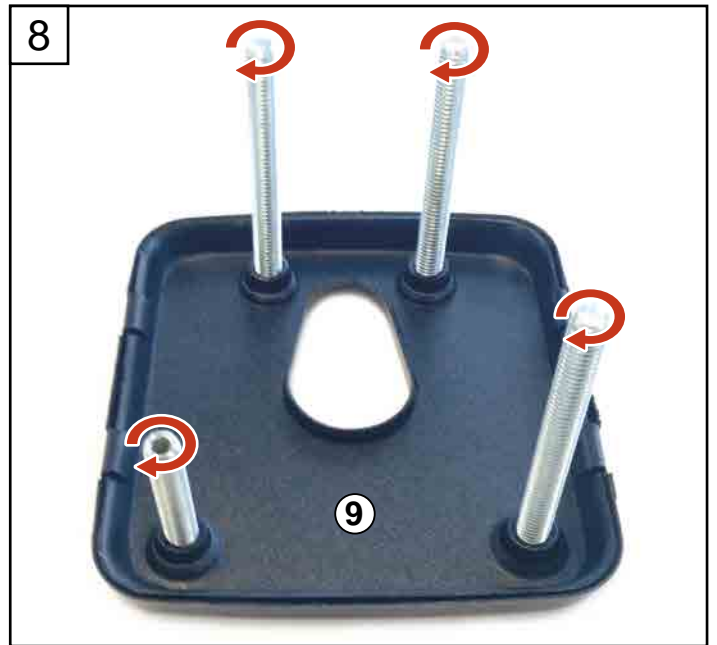
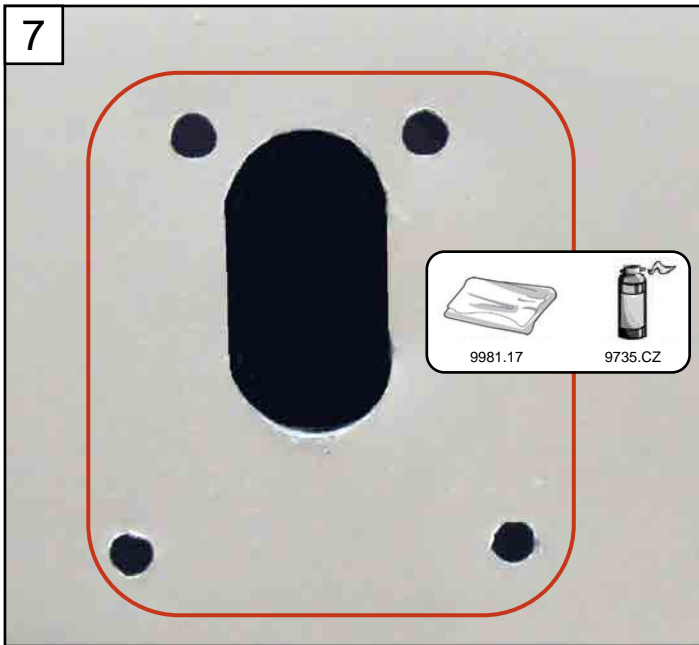

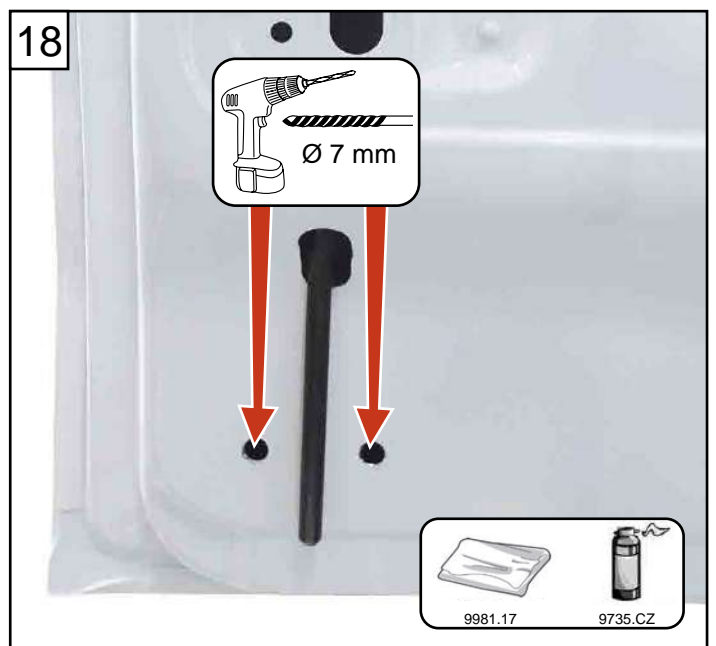
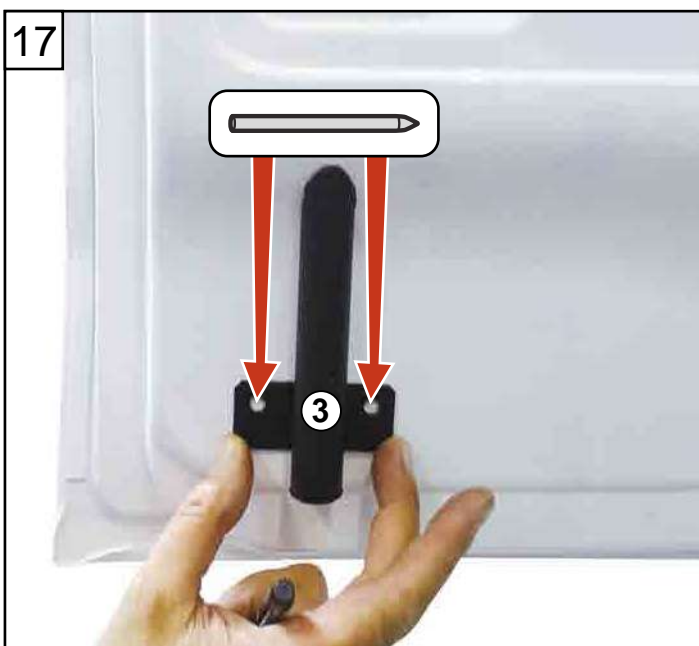
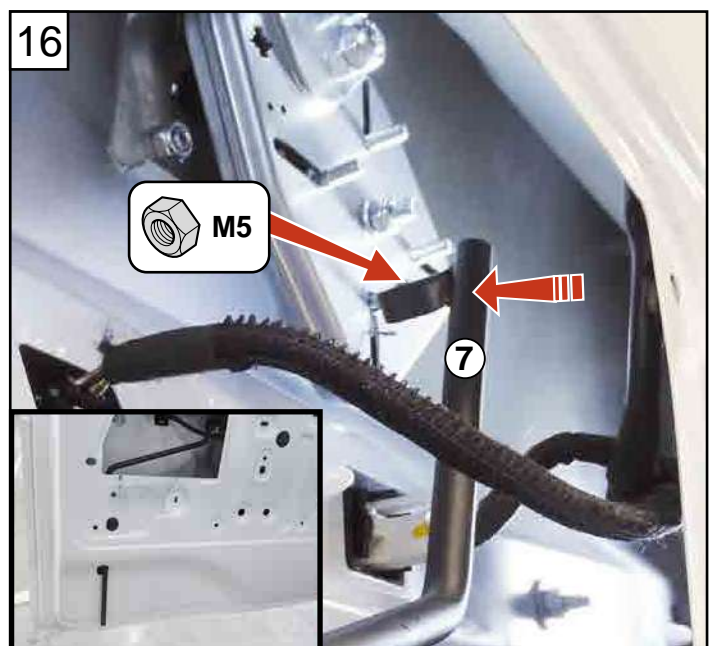
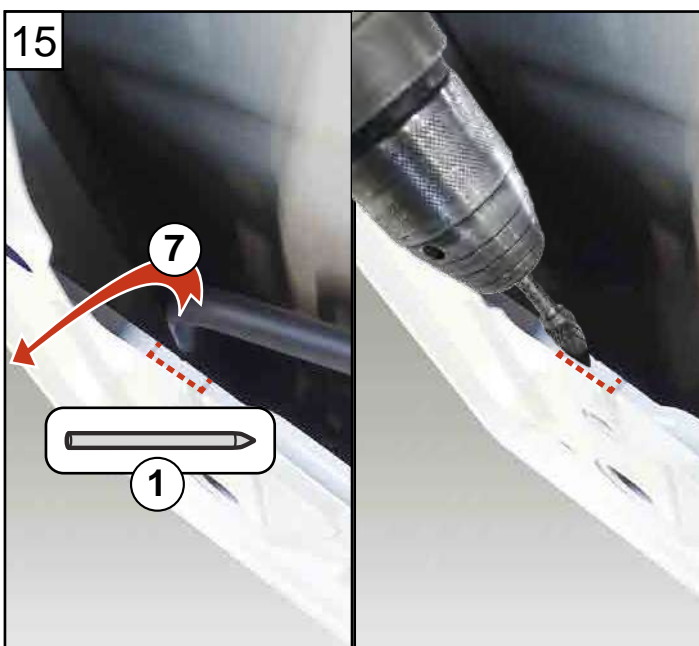
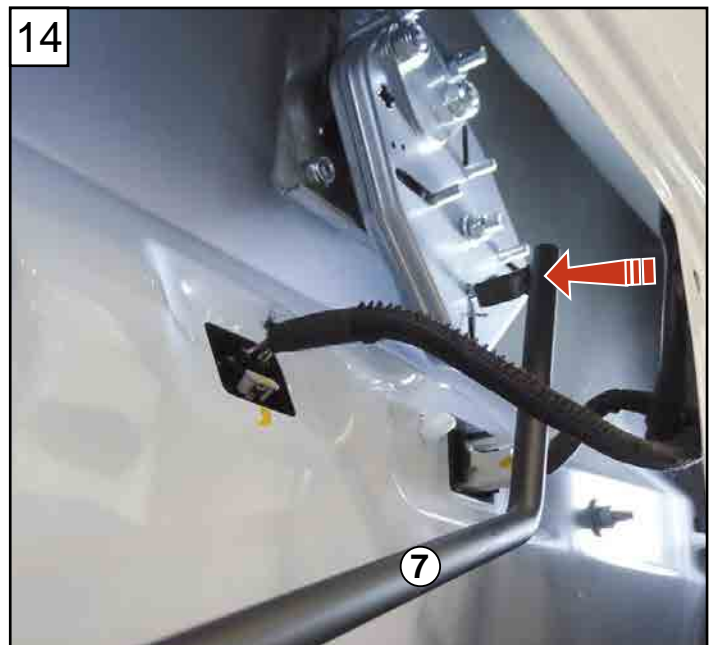
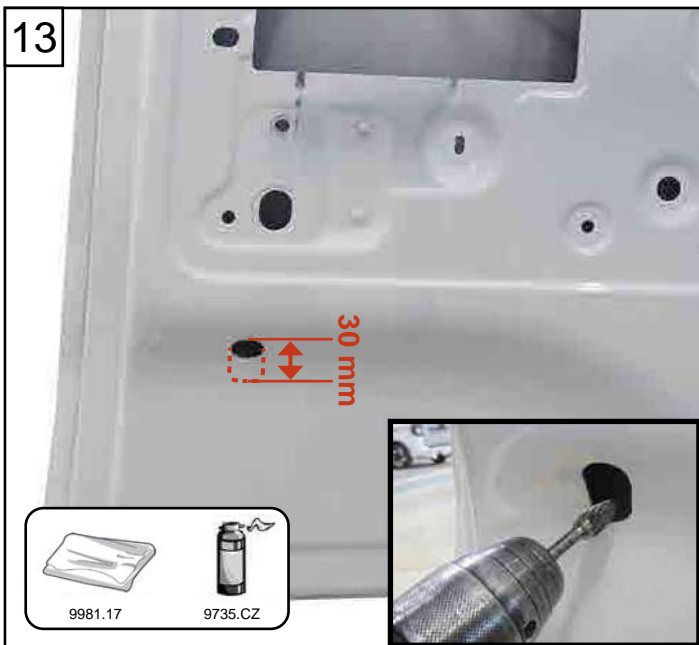

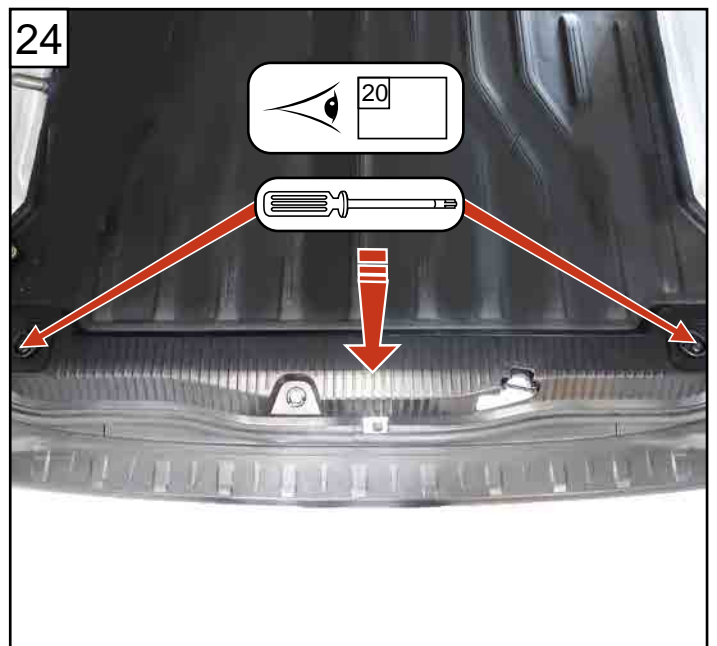
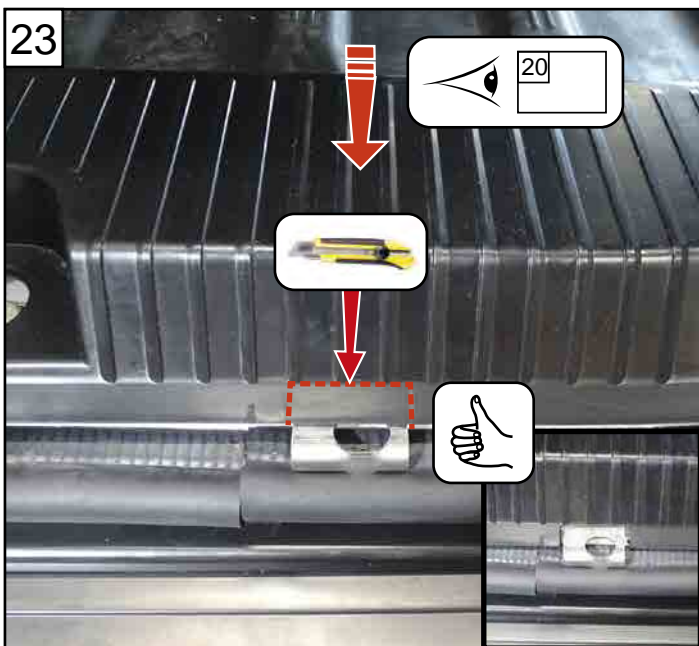
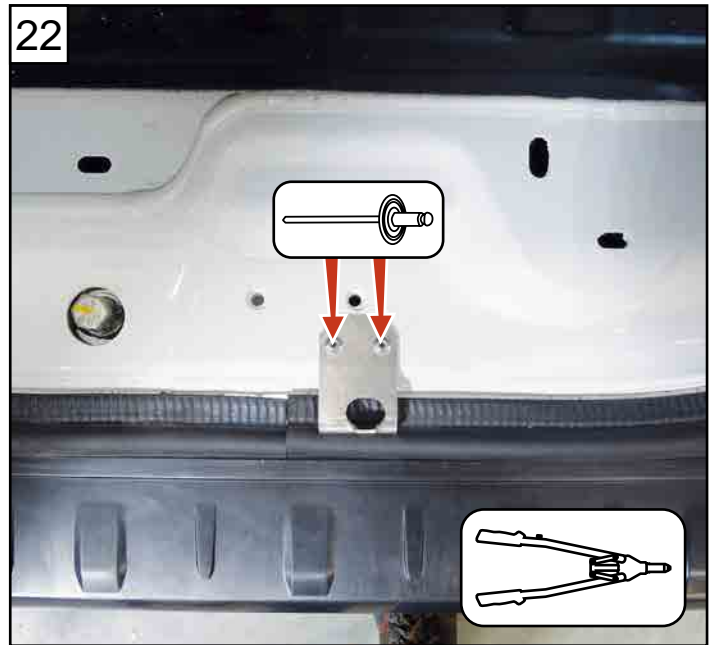
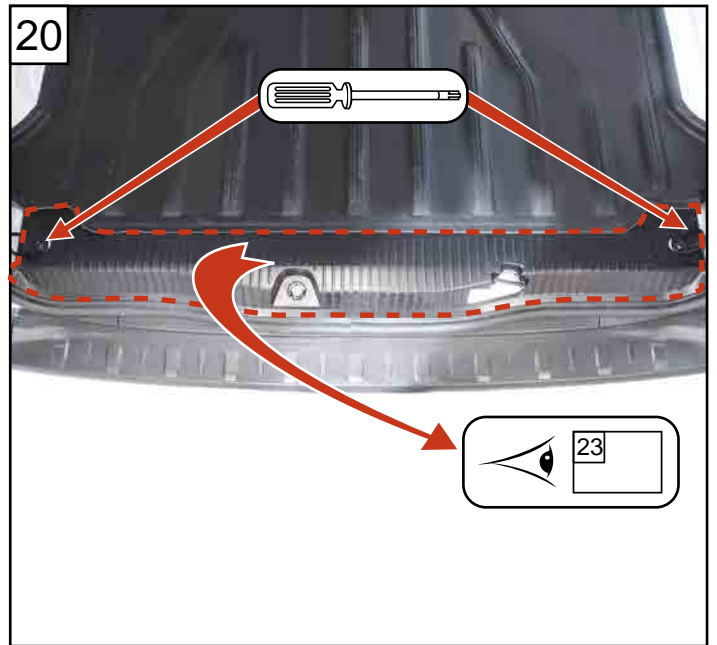
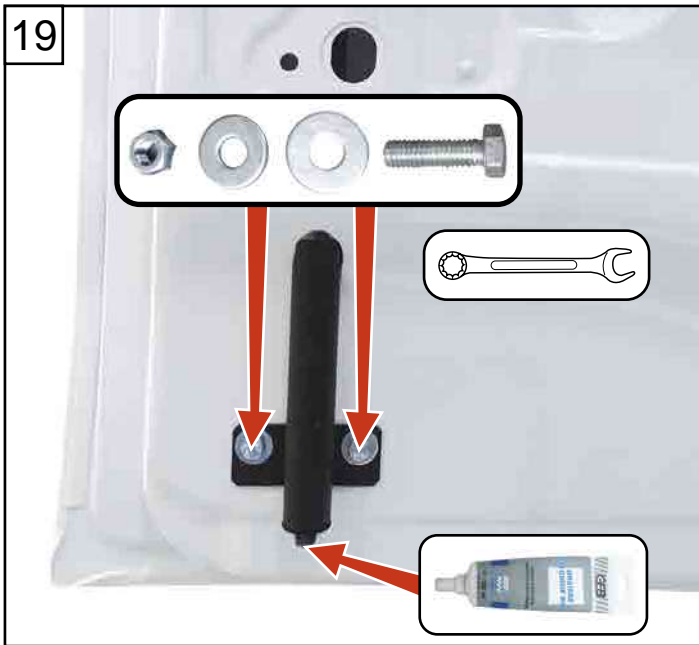

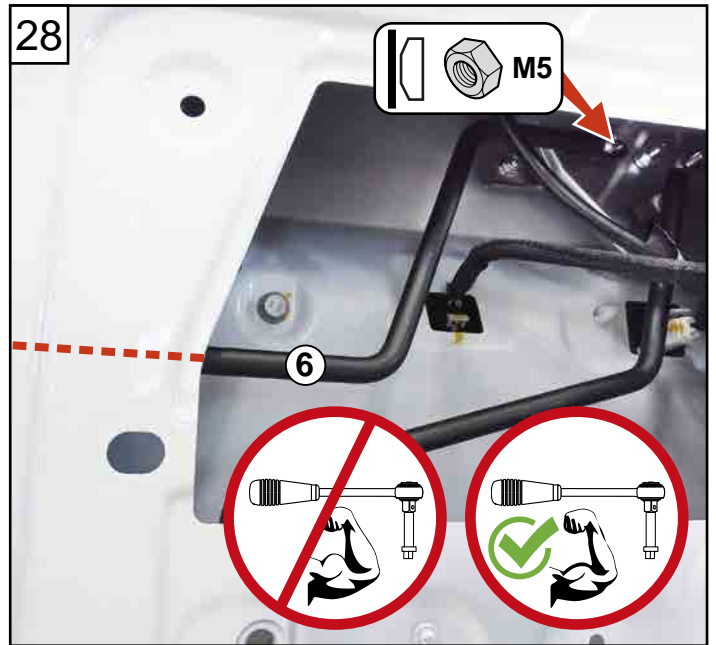

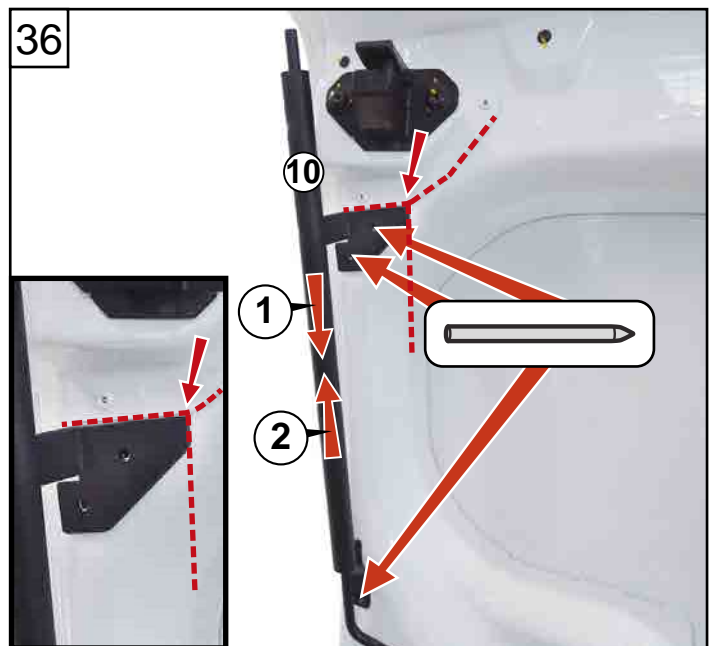
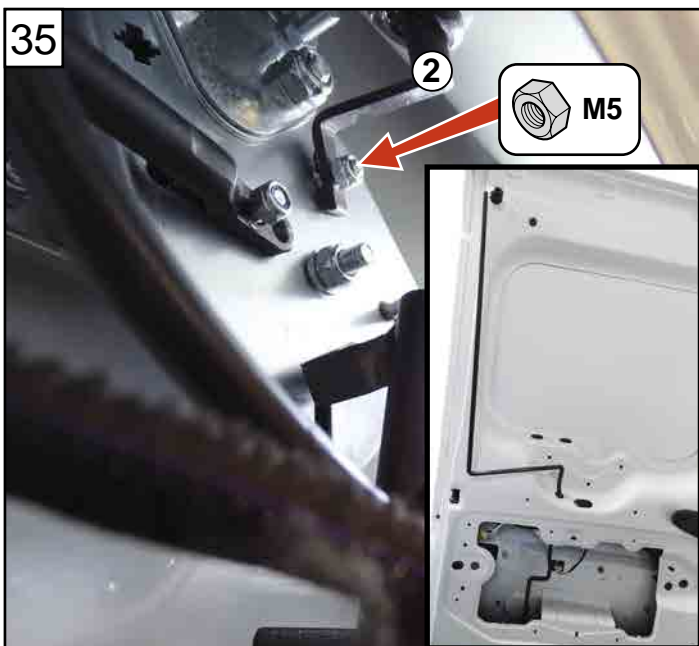
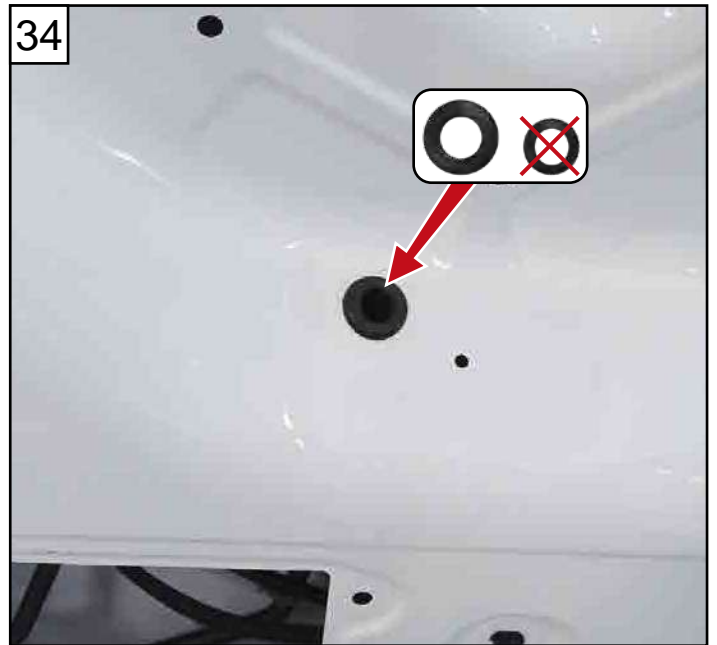
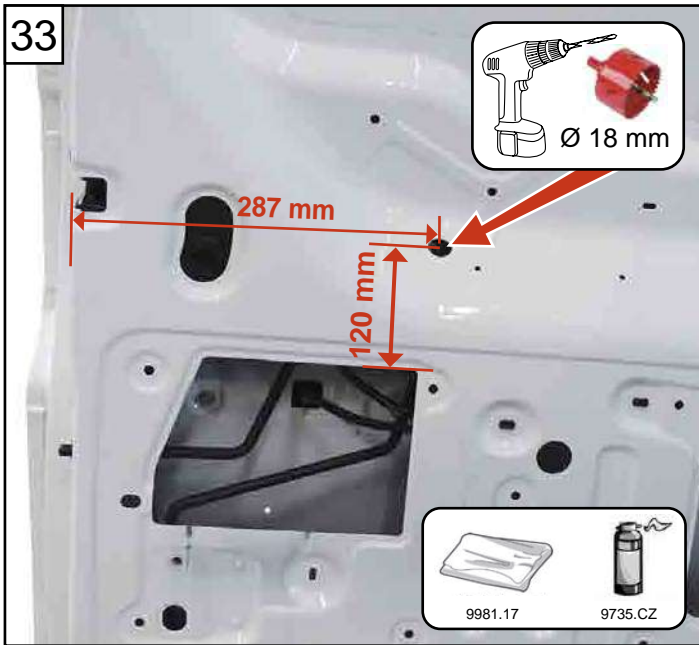
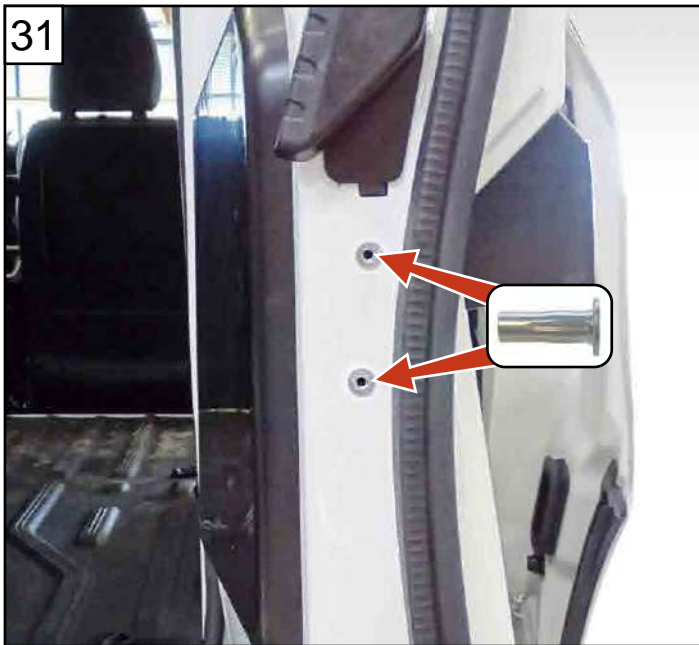

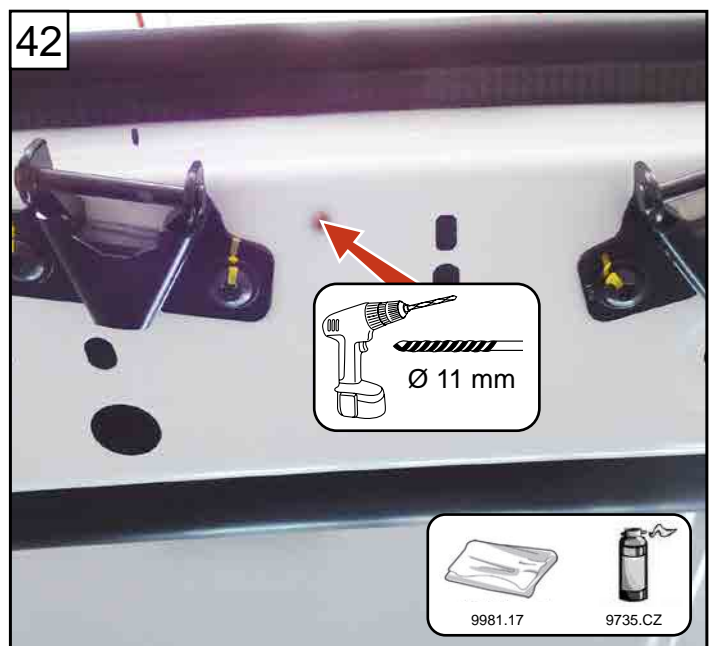
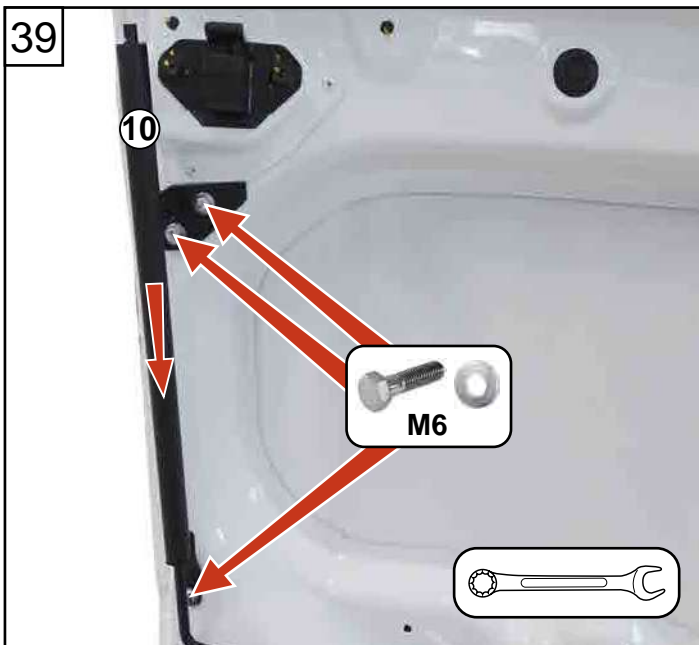
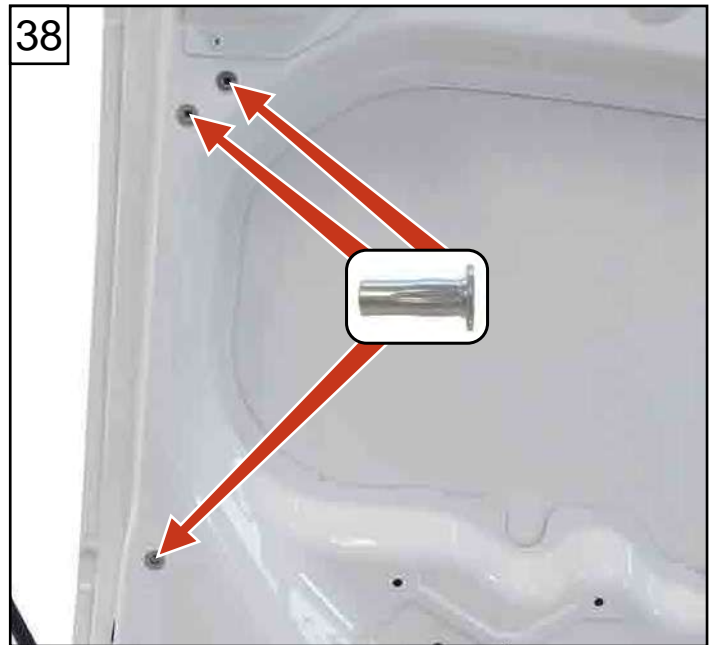
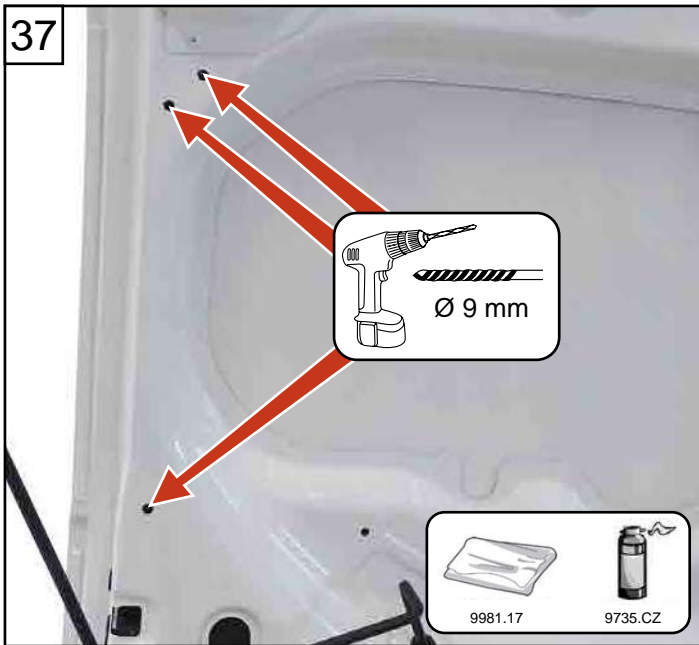

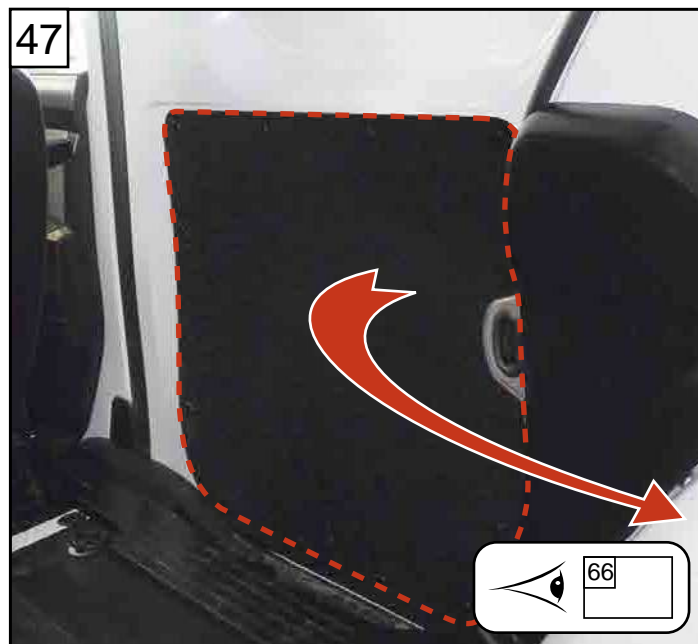
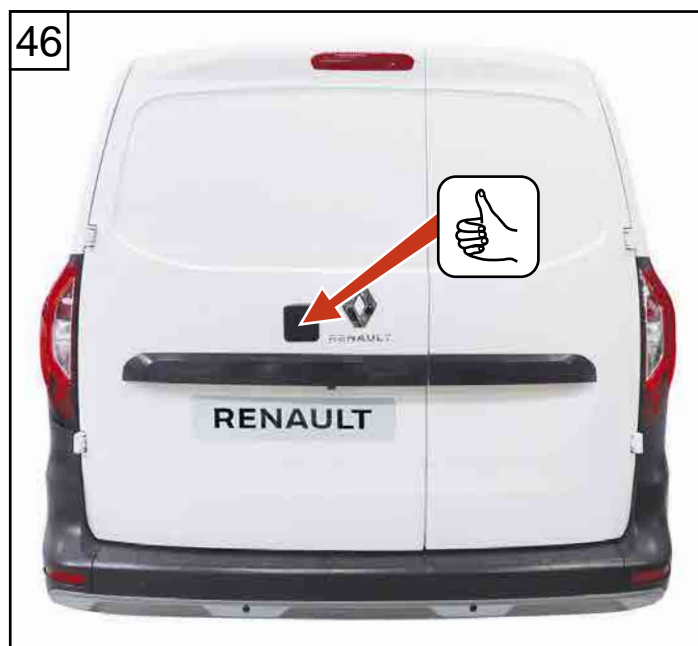
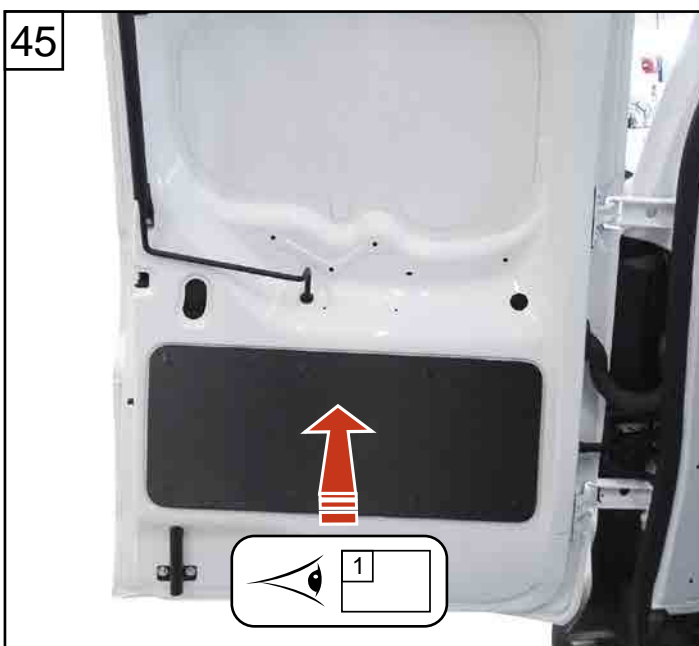
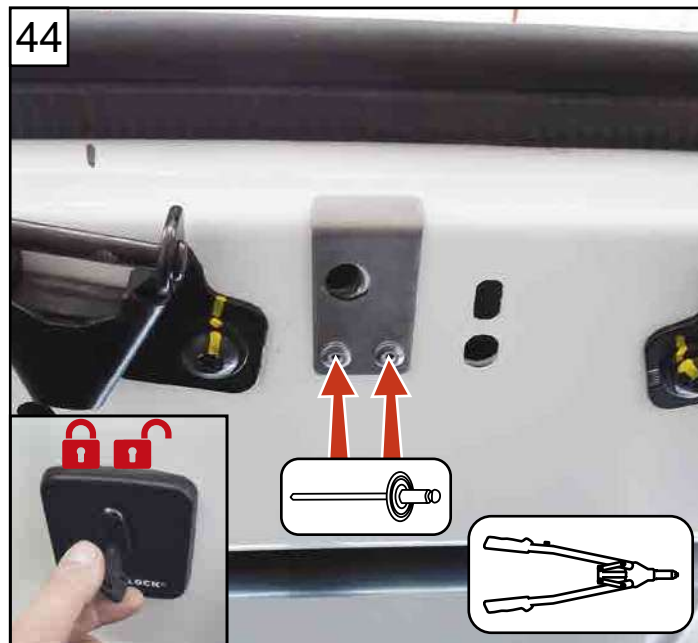
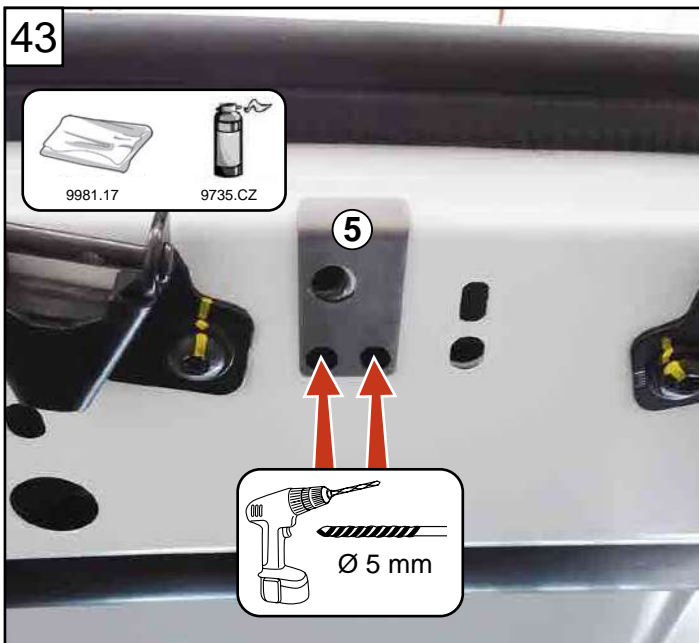

48

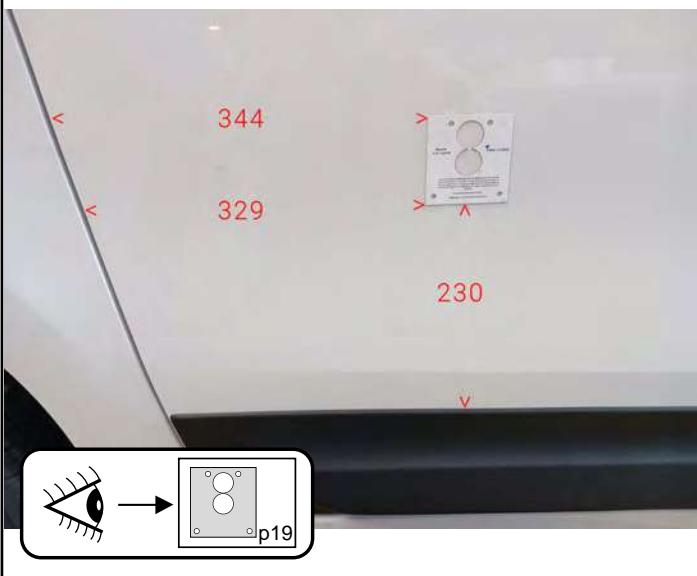

49

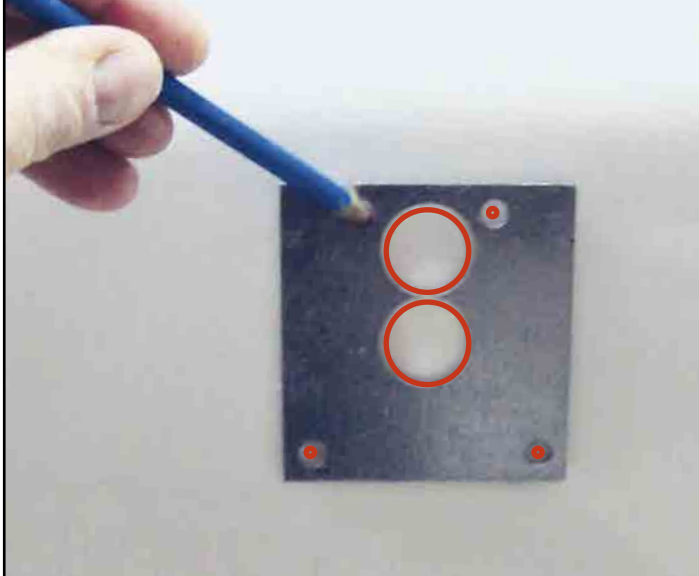

50

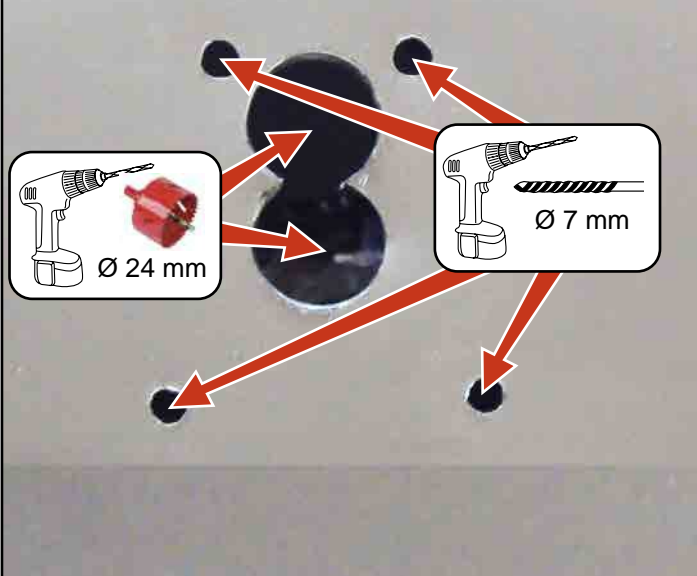

51

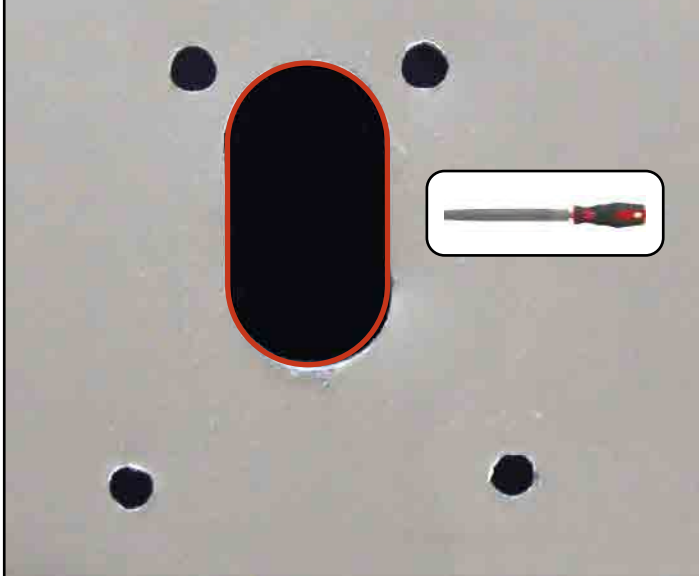

52

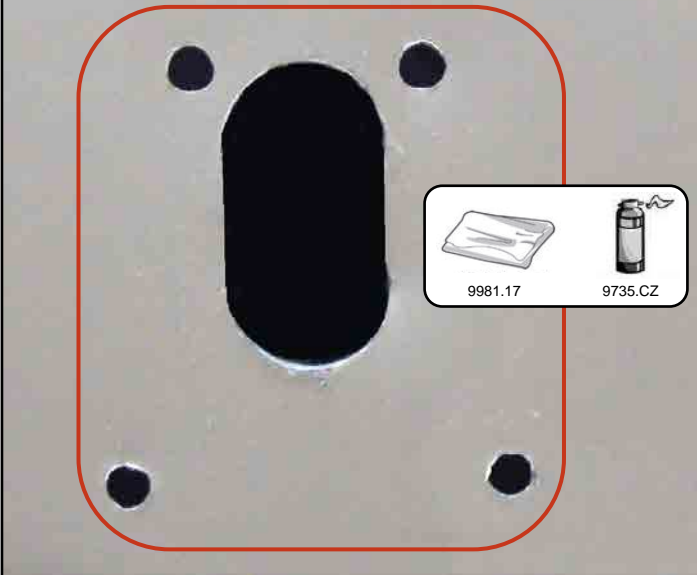

53

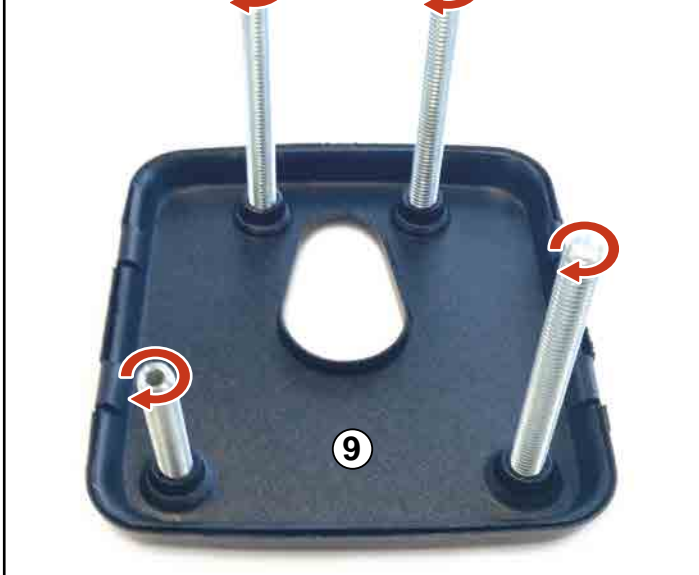

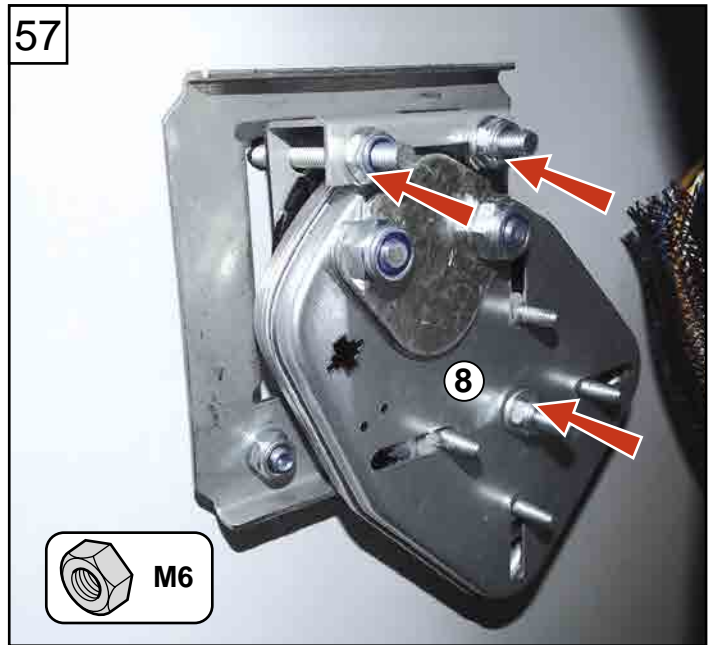
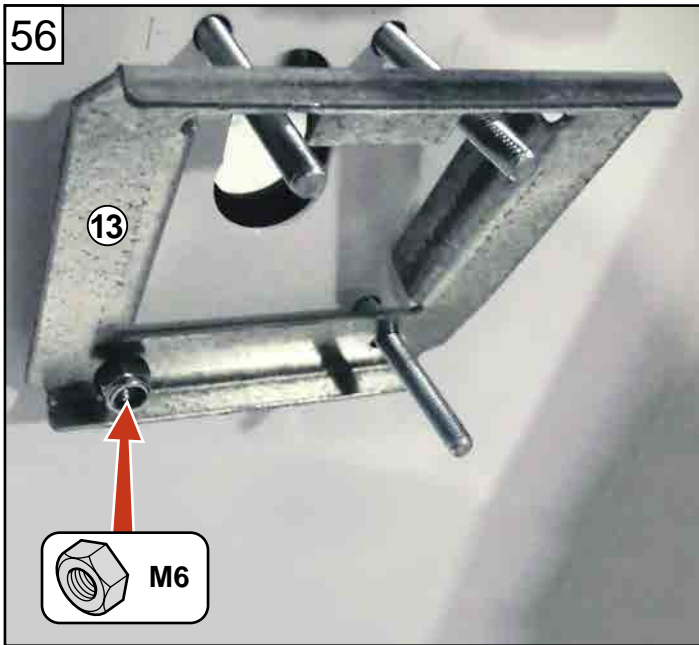

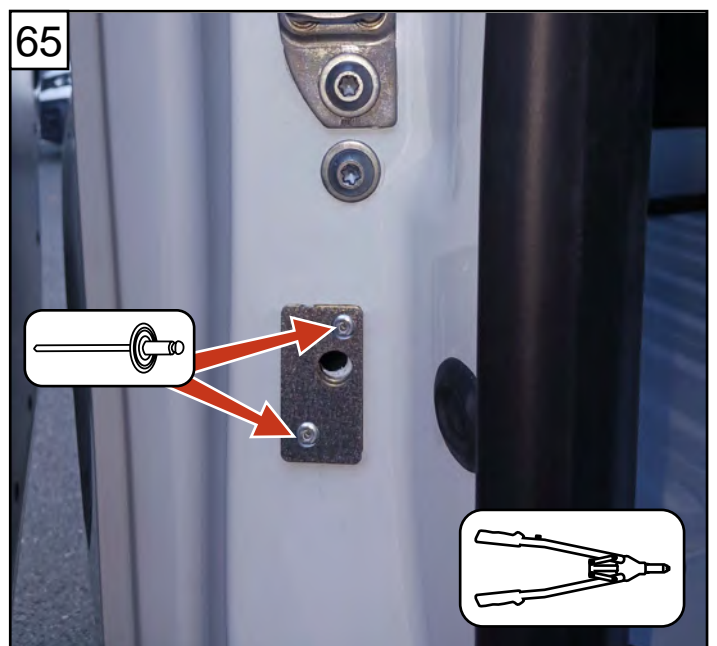
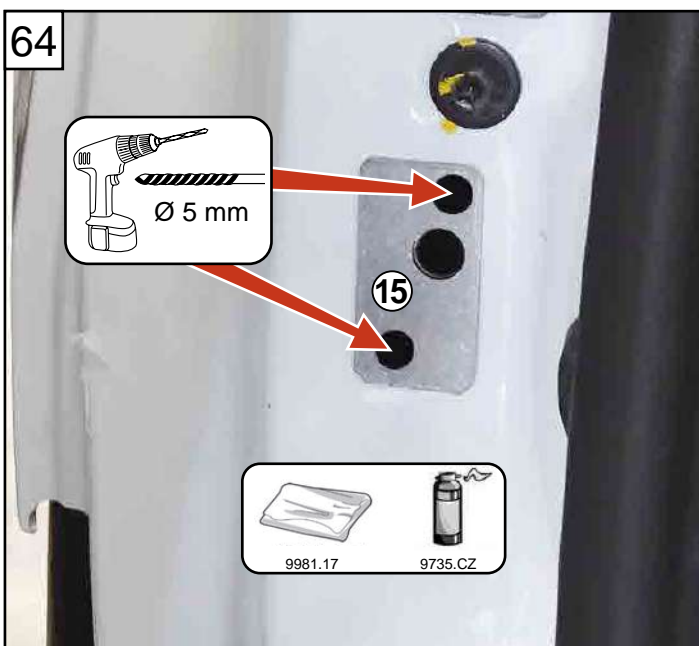
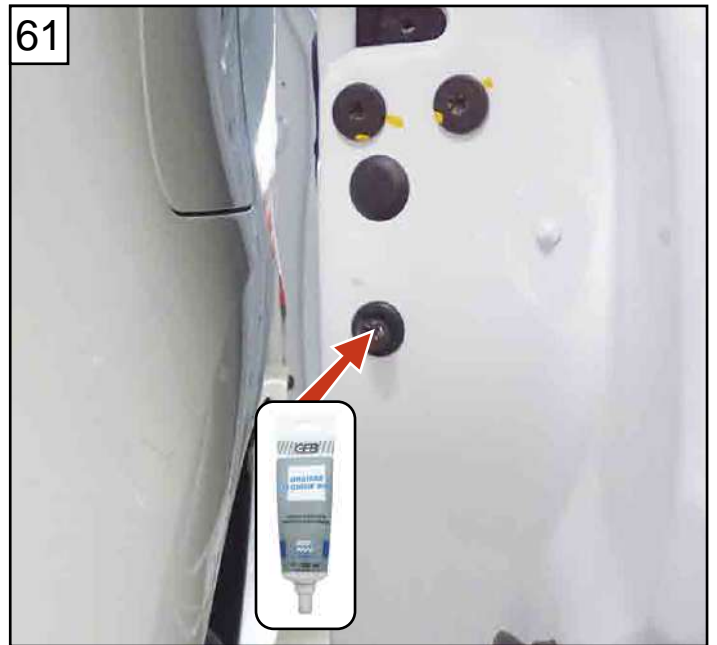
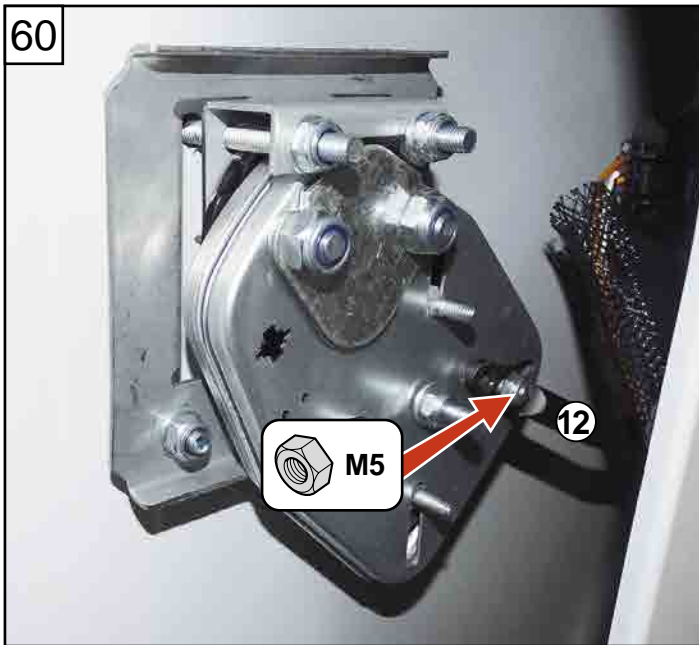

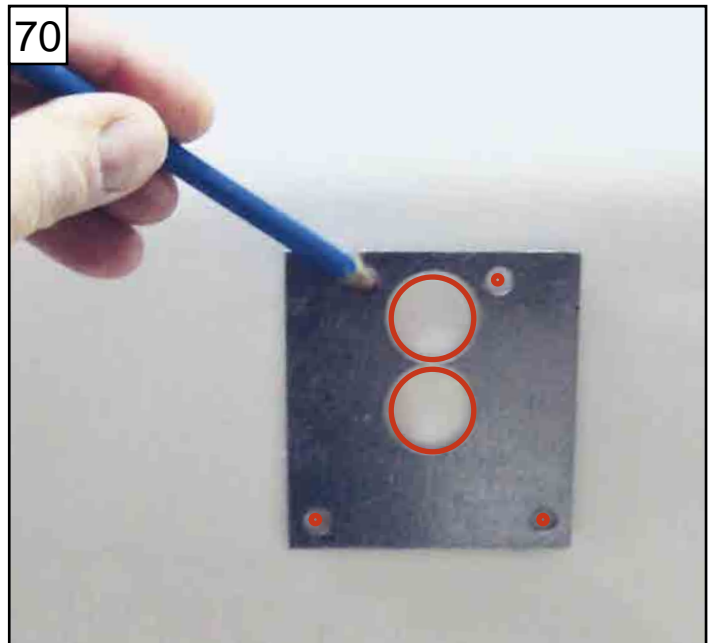
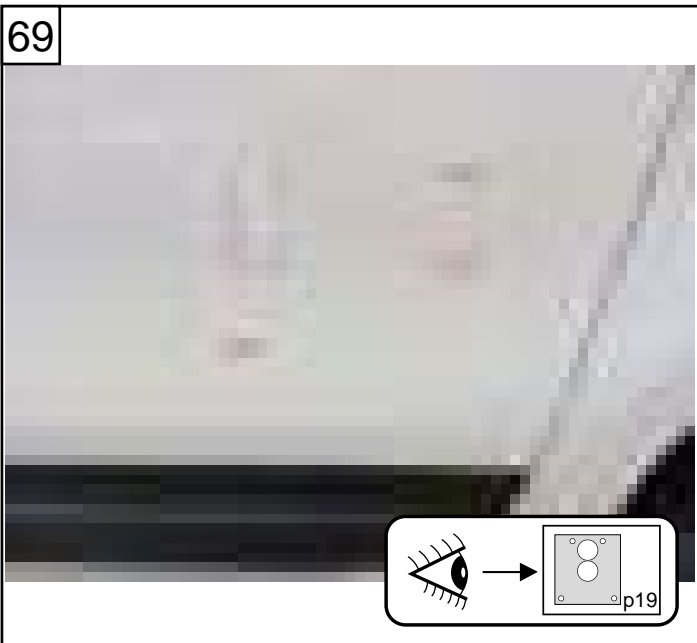
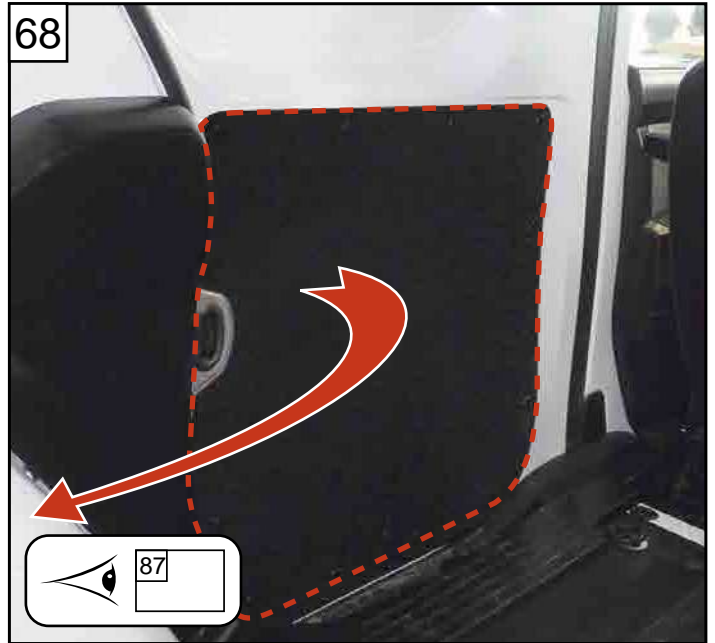
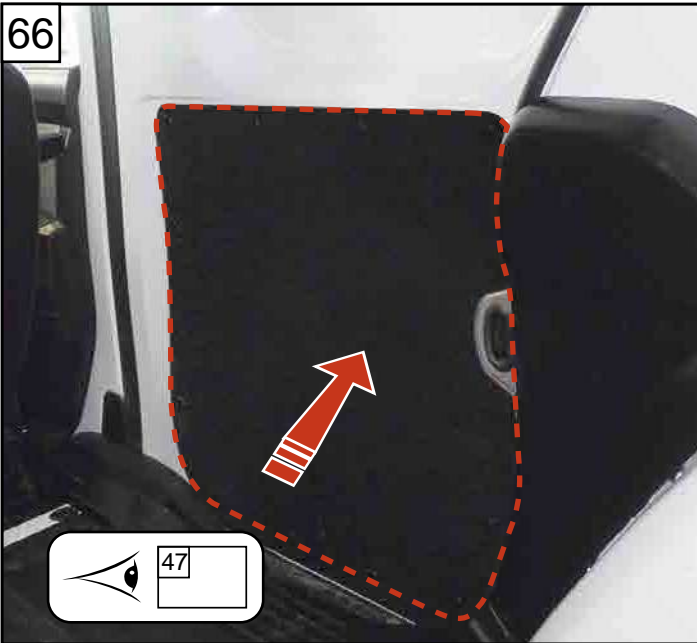

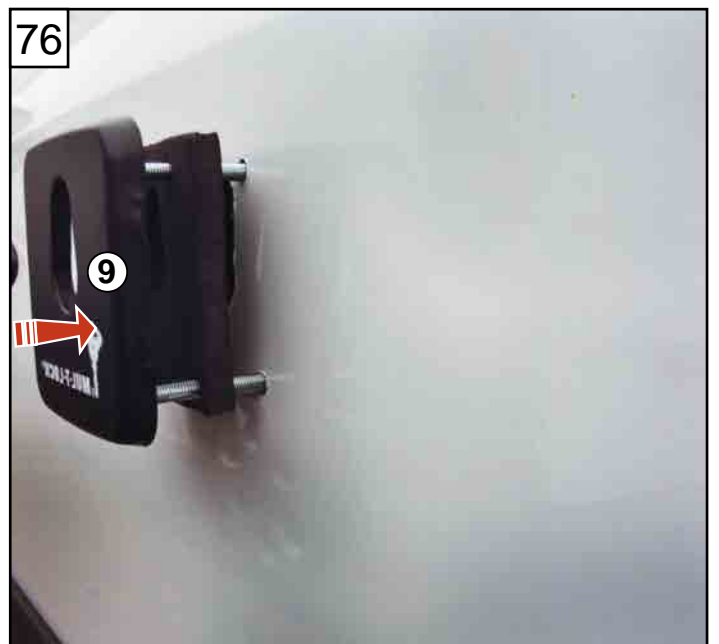
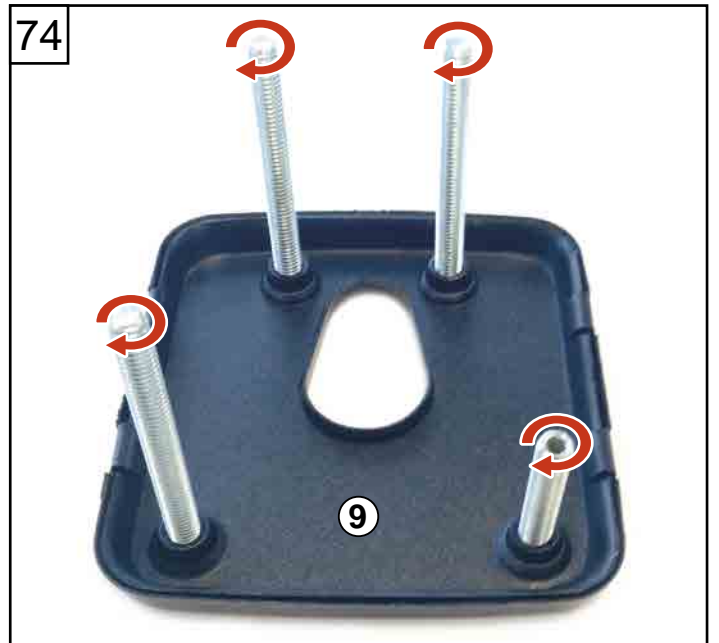
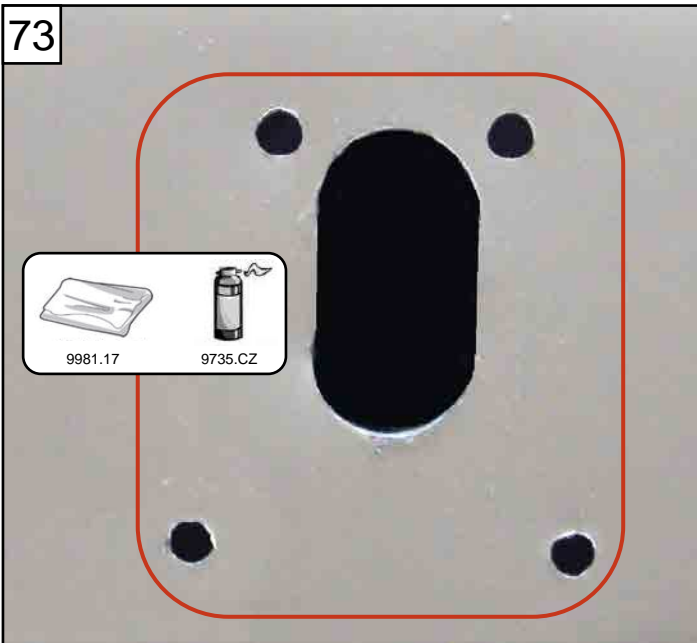
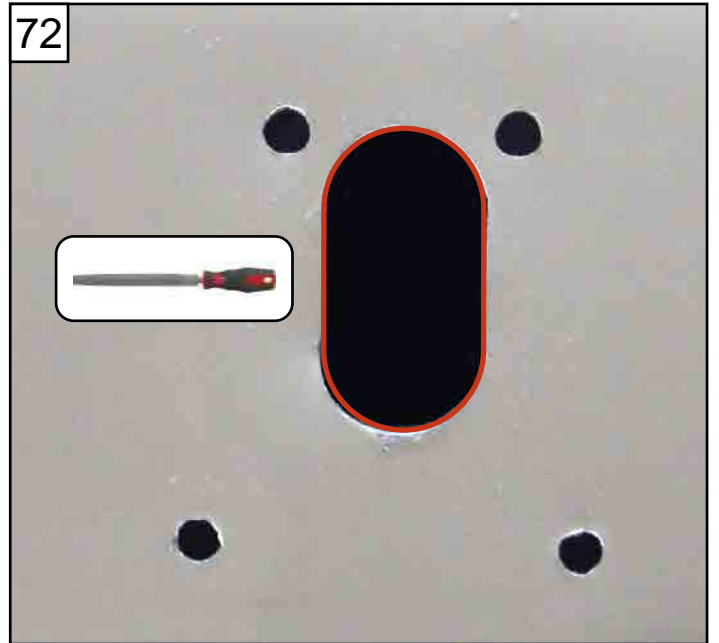
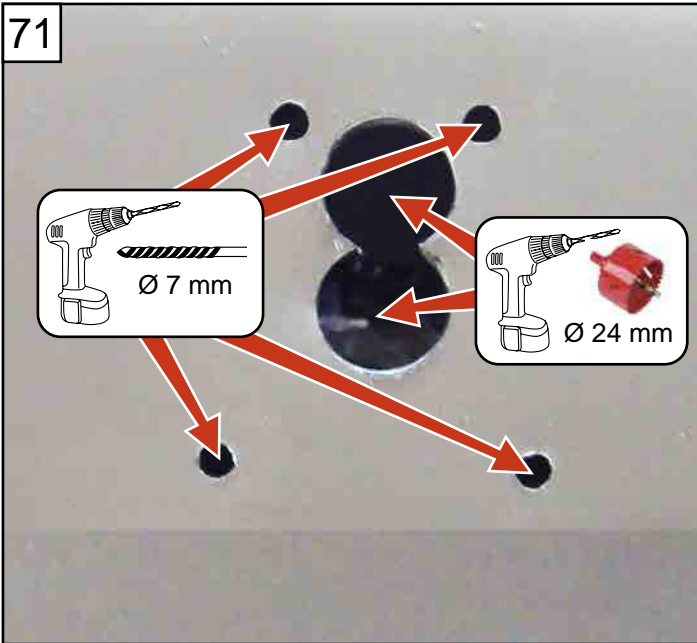

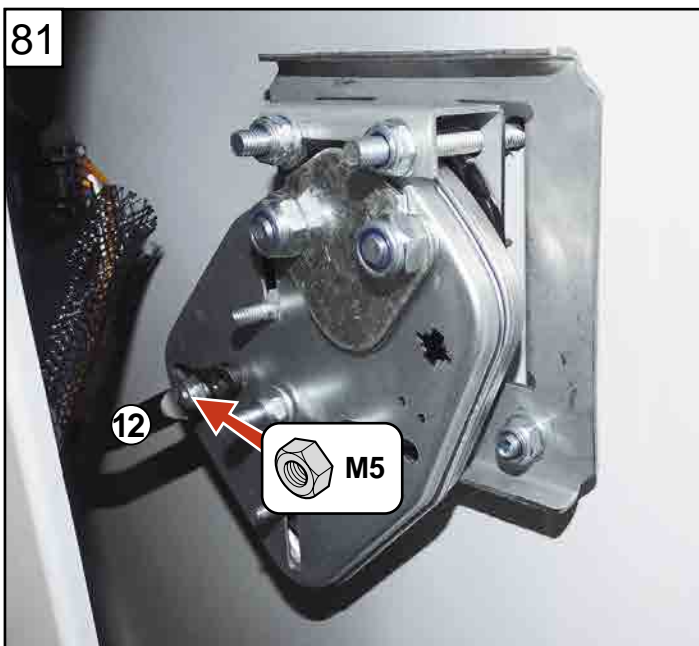
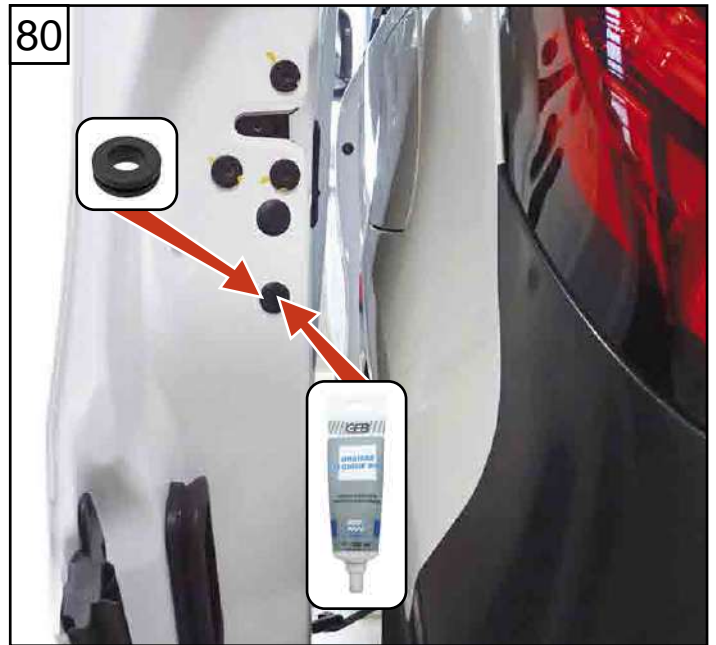
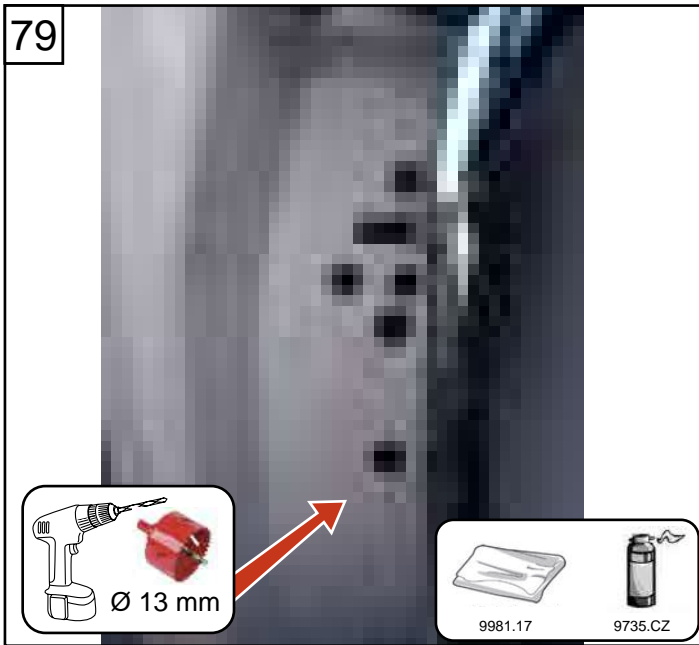
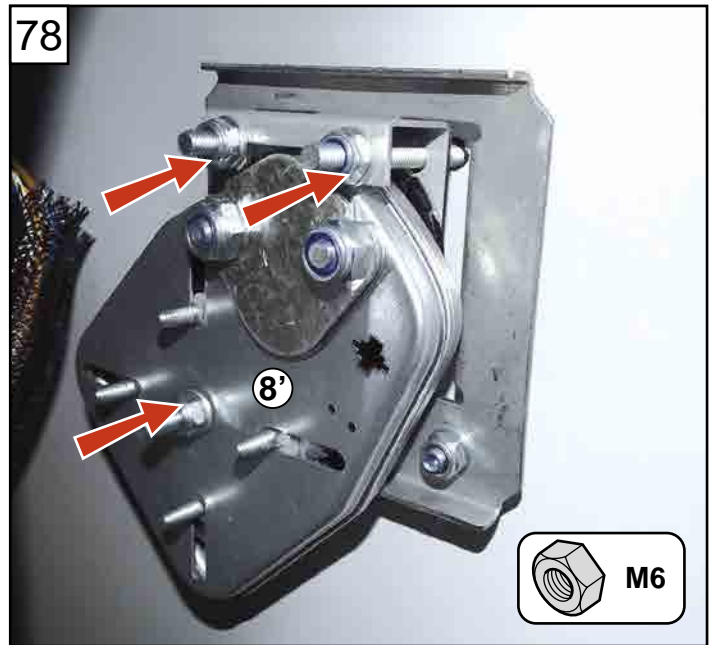
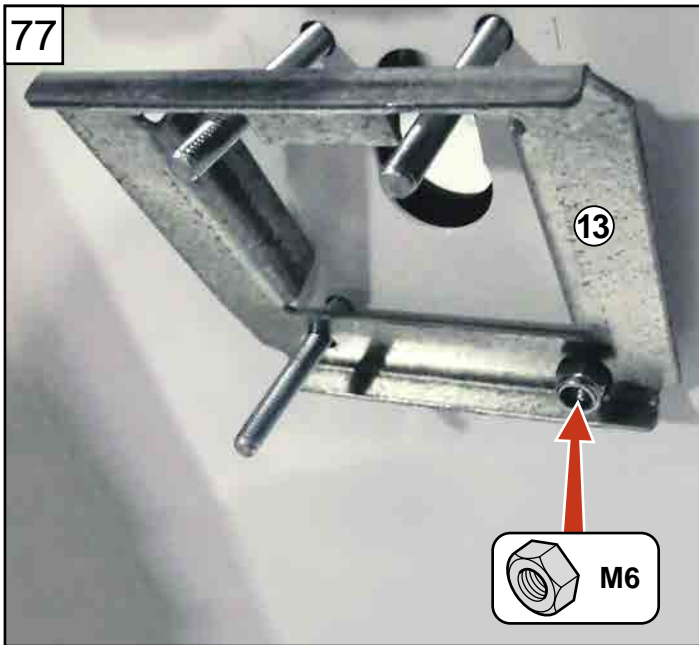

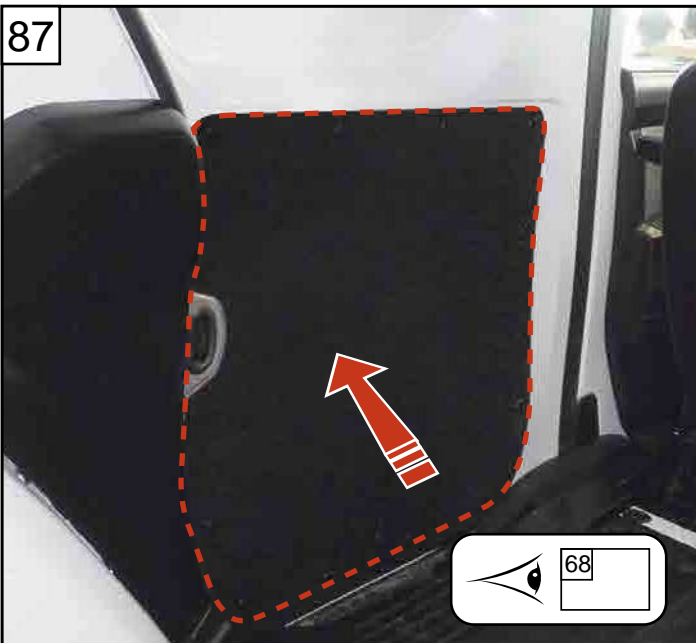
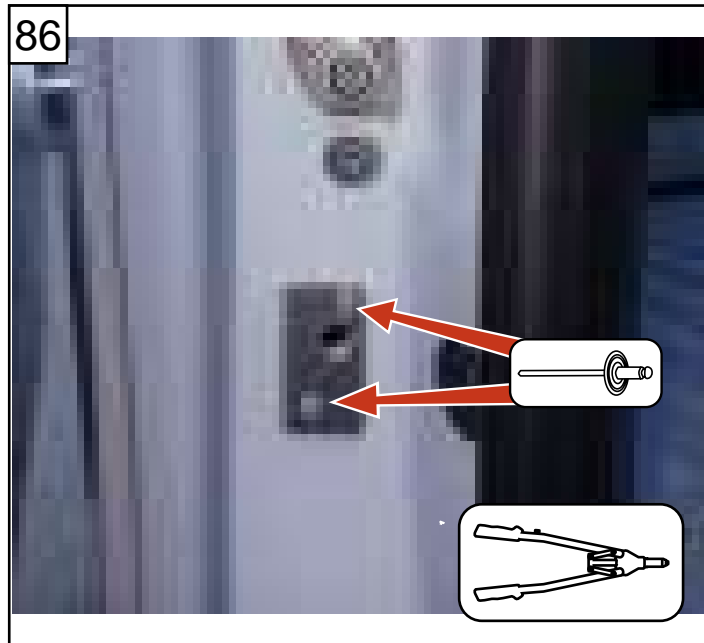
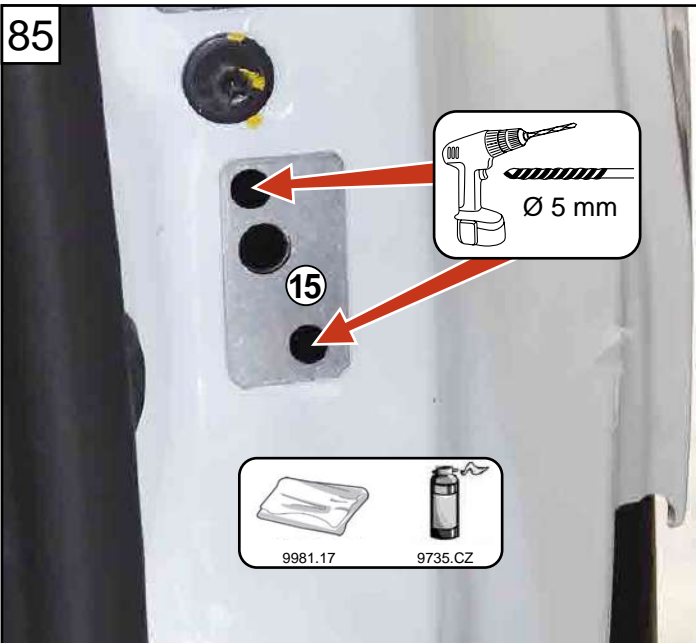
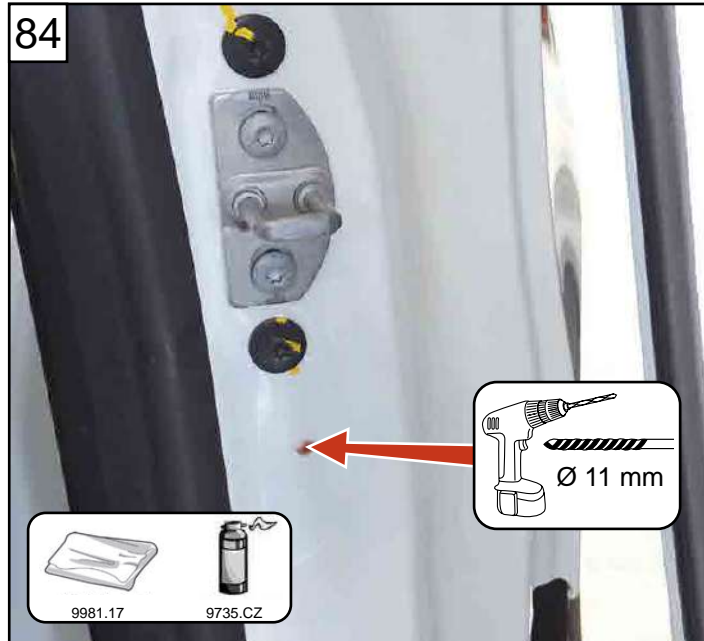



100%

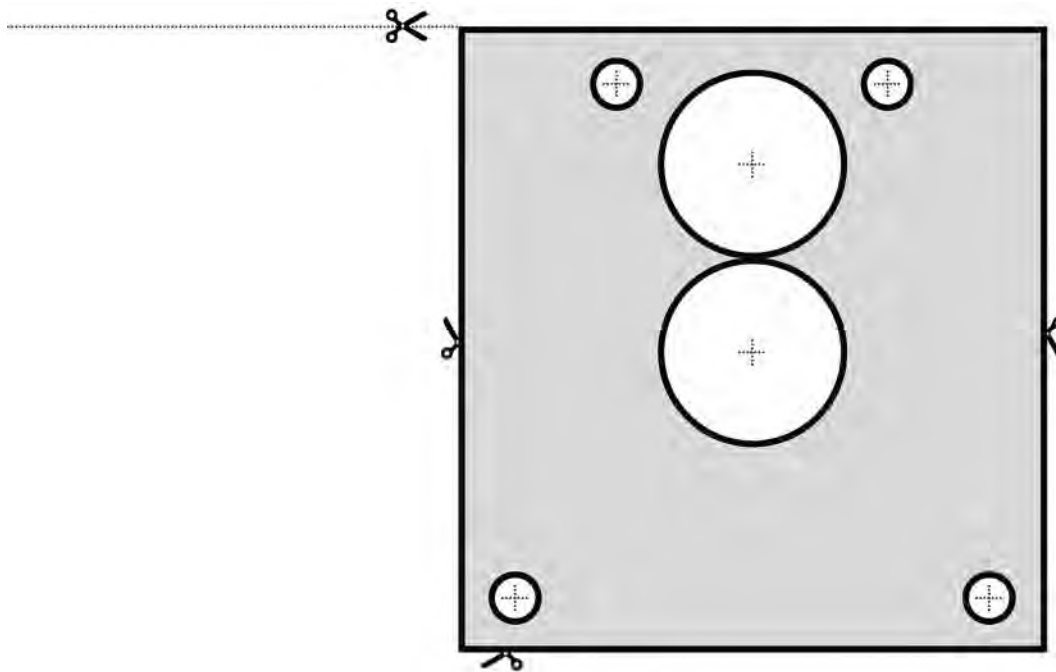

3 cm





DIVISION AUTOMOBILE MUL-T-LOCK

**4 AVENUE D'OUessant
91140 VILLEBON SUR YVETTE**

Tél. : 01 41 28 39 70

Fax : 01 69 53 01 85



SUPPORT COMMERCIAL

01 41 28 39 70

adv@mul-t-lock.fr

SUPPORT TECHNIQUE

automobile@mul-t-lock.fr

**TOUTES LES PHOTOS DE LA PRÉSENTE NOTICE SONT LA PROPRIÉTÉ EXCLUSIVE DE MUL-T-LOCK.
REPRODUCTION STRICTEMENT INTERDITE. NOTICE RÉSERVÉE EXCLUSIVEMENT AUX PRODUITS DE LA MARQUE MUL-T-LOCK.**